

sermas

THE SERVICES YOU ARE EXPECTING



03/04/2020

STAS-SERVICES by SERMAS_V3-R0_Eng

OUR OFFER & MEANS

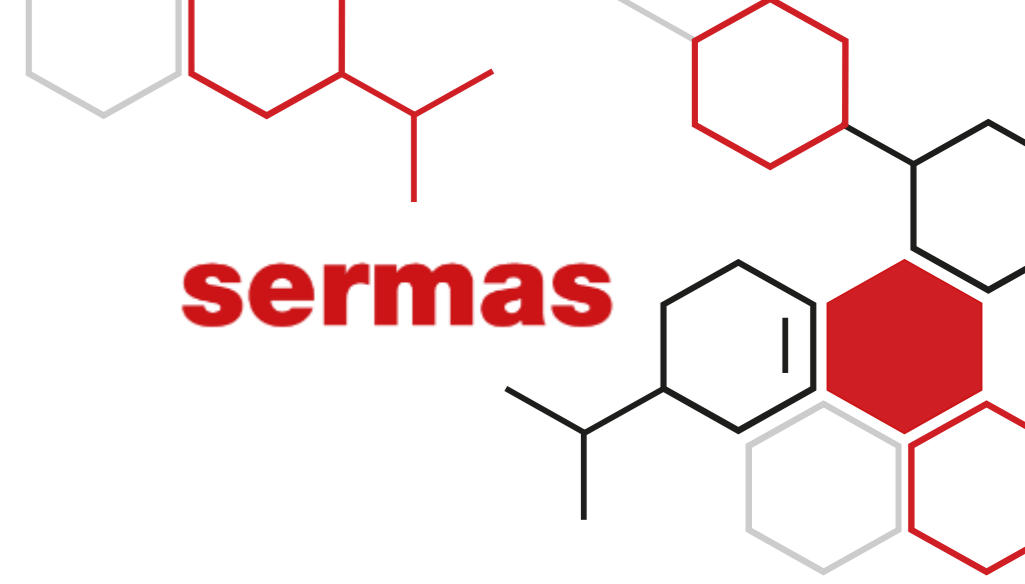

- **Travelling experienced sales engineer for assistance and advice**
- **Extensive stock for critical parts offering short lead time**
- **Internal logistic & experienced staff dedicated to after-sales**
- **Prompt reply to your inquiries**
- **Quick deliveries with qualified forwarders network**



TECHNICAL ASSISTANCE

sermas



- **Audit** of your equipment
- Mechanical **adjustments** (blade-guide rollers, lubrication...)
- **Optimum cutting parameters** setting for your application
- **Consumables** and **spare parts** recommendations
- **Technical advices** for maximum production availability
- Customized **training** for your maintenance and production teams
- On-line and **on-site technical support**



PREVENTIVE MAINTENANCE

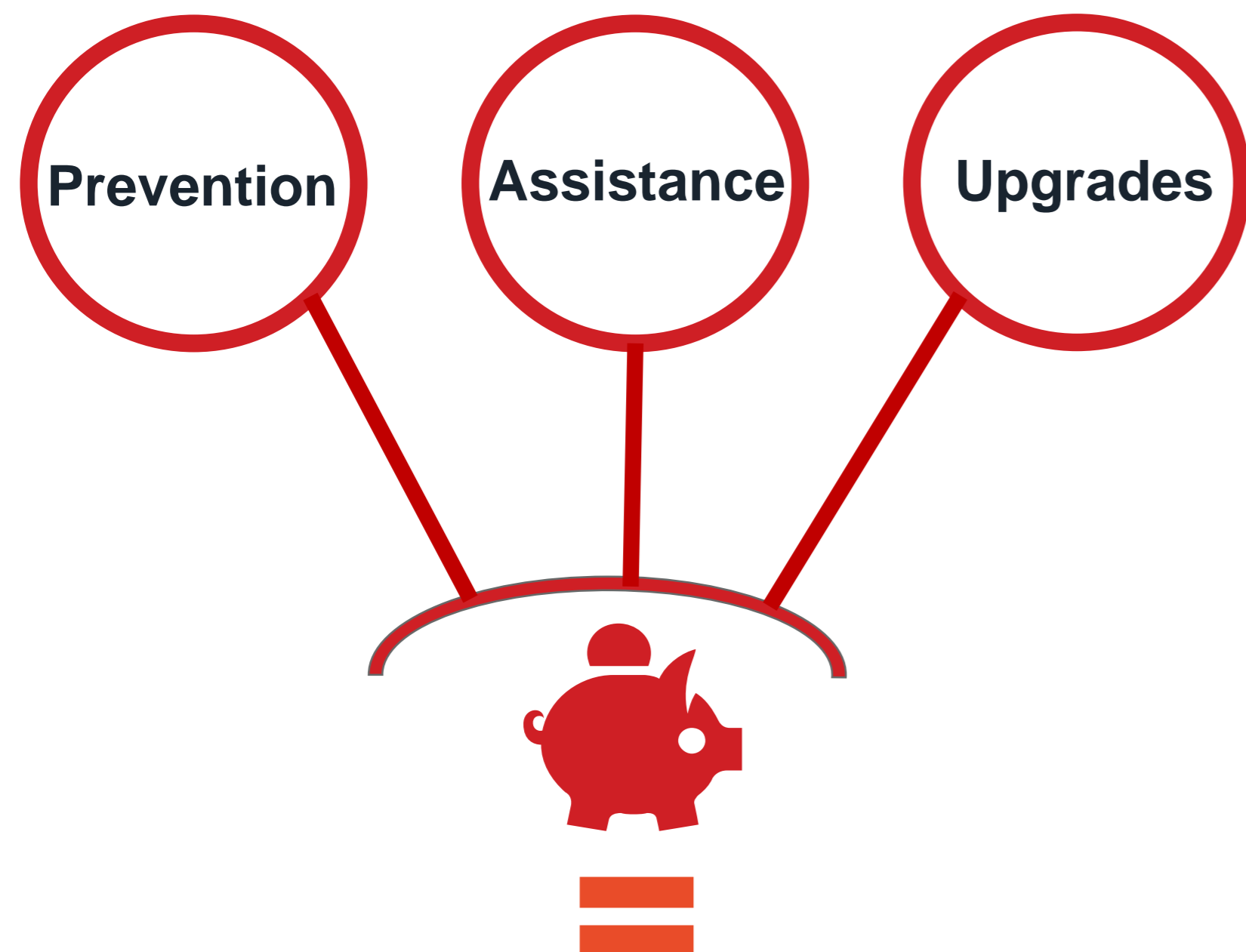

CUSTOMER TRUST

- Prevent short terms failures & breakdown
- Assist your staff for preventive maintenance
- Upgrades opportunities for highest production's requirements

sermas

Annual preventive maintenance proceed by our technical experts guarantees optimal performance of your equipment

- On-site technical assessment of your equipment
- Replacement of first emergency spare-parts available
- Global performance optimization (sawing tests, etc.)
- Debriefing meeting with maintenance / production staff
- Detailed and illustrated technical report
- Expert recommendations for process improvement



HIGH-PERFORMANCE CONSUMABLES: SAW-BLADES & LUBRICANTS

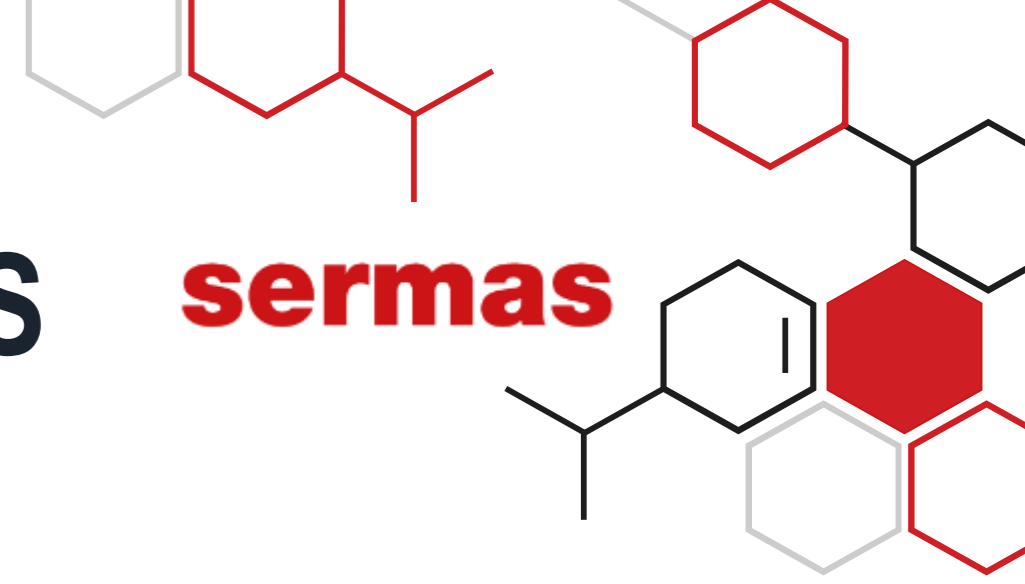

EXPERTISE
47 years

Expertise recognized
Aluminium and non-ferrous sawing



- Production & maintenance reduction costs by specialized high-efficiency consumables
- R&D program to specifically adapt our consumables to your application
- Top-quality service, technical support & on-site assistance for process optimization

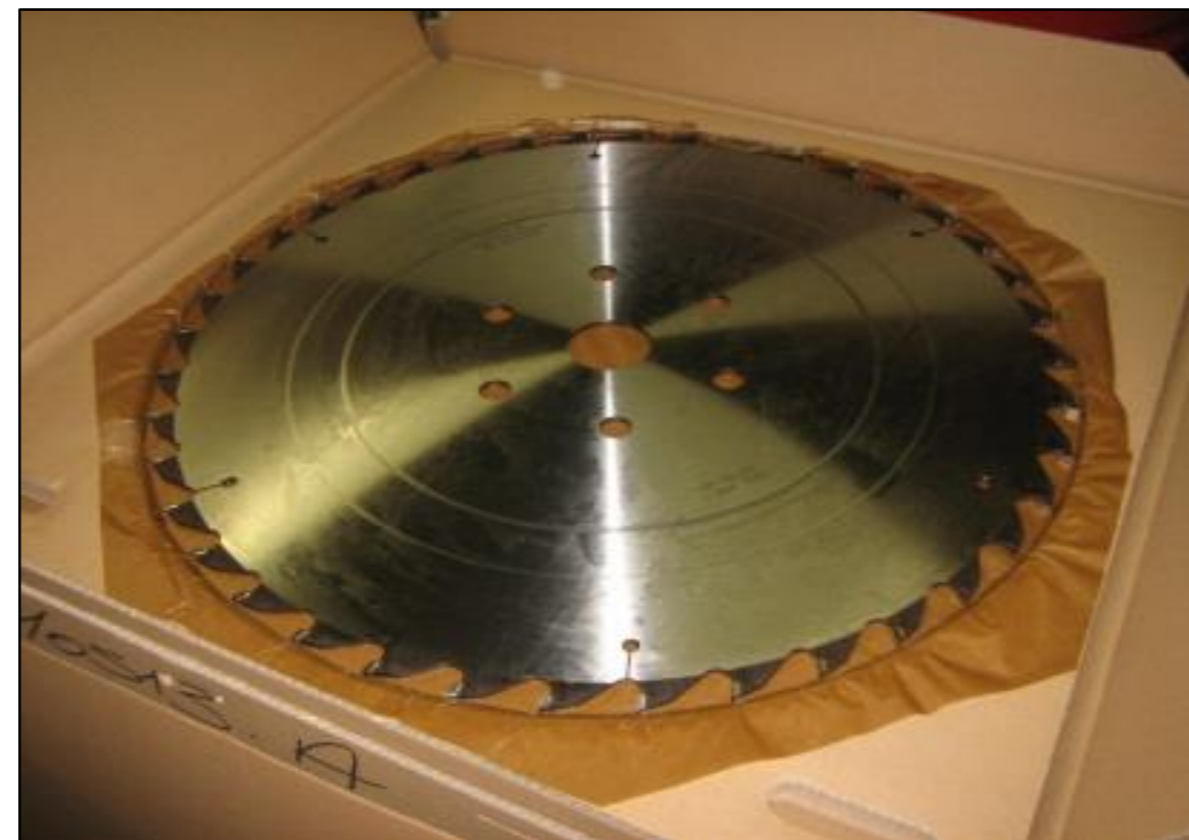

SAWS PERFORMANCE WITH SERMAS CONSUMABLES

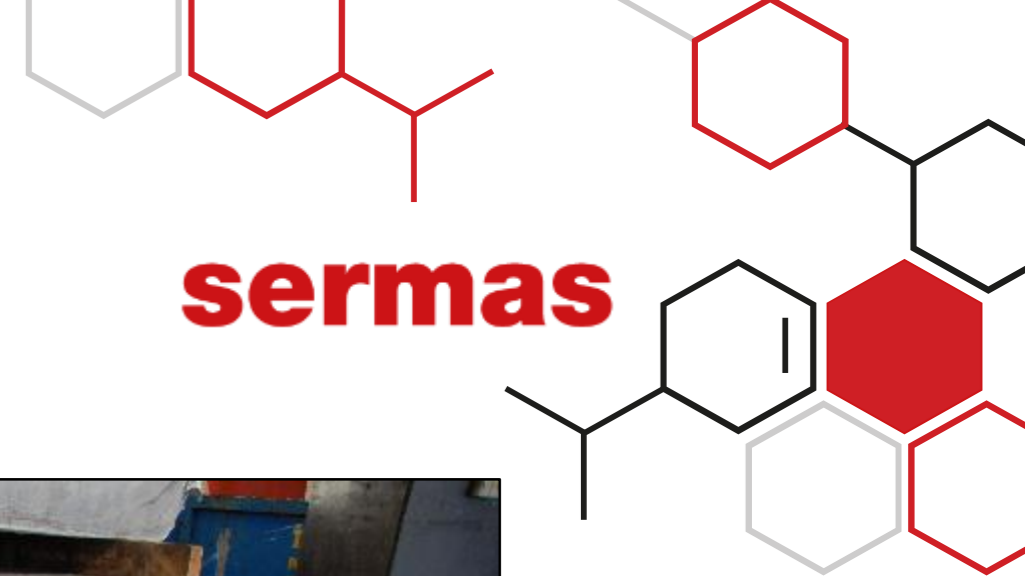

SAWS PERFORMANCE WITH SERMAS CONSUMABLES

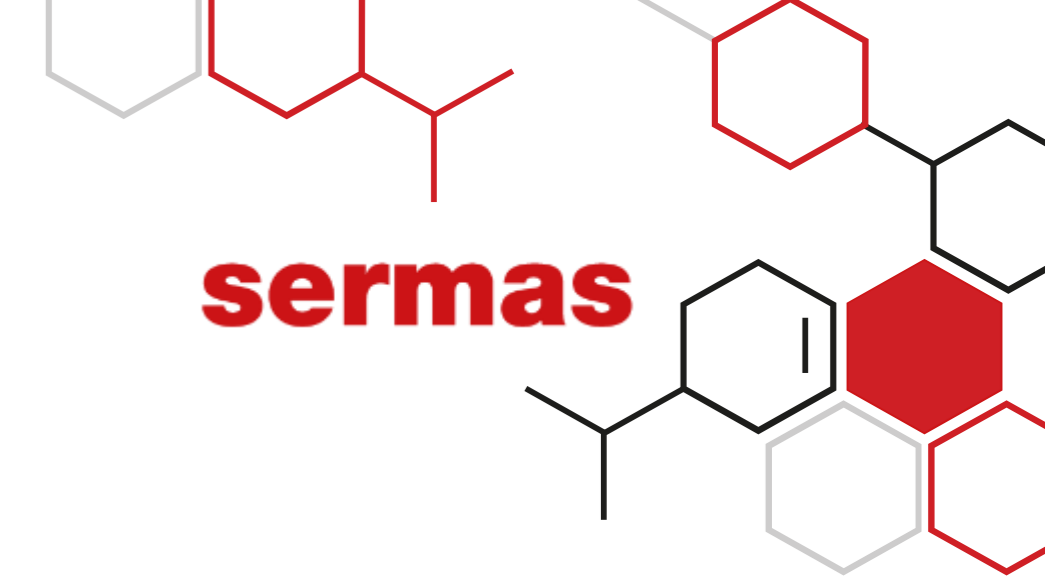

IMPROVEMENTS TO REDUCE MAINTENANCE COSTS

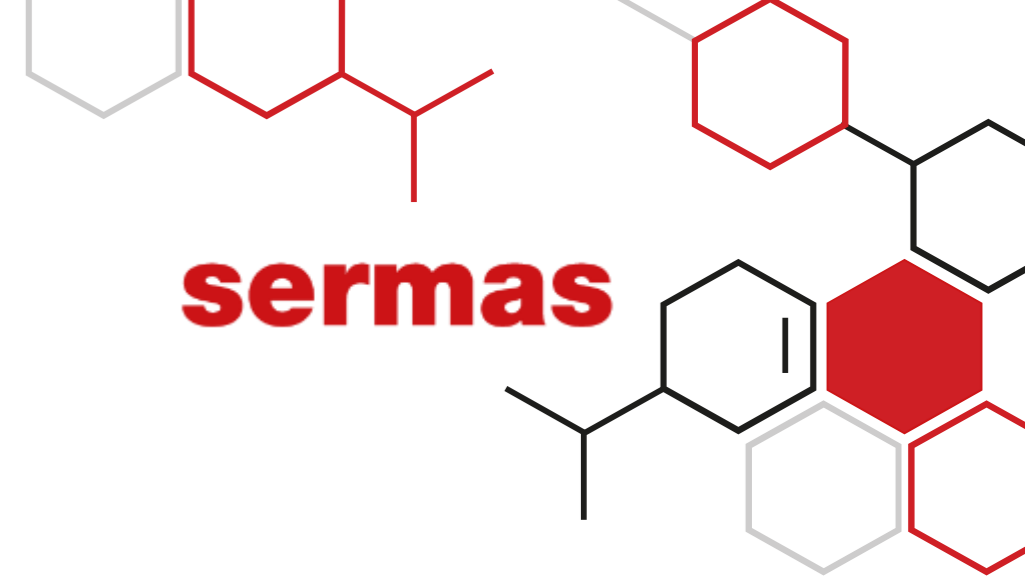

Blade-guide rollers

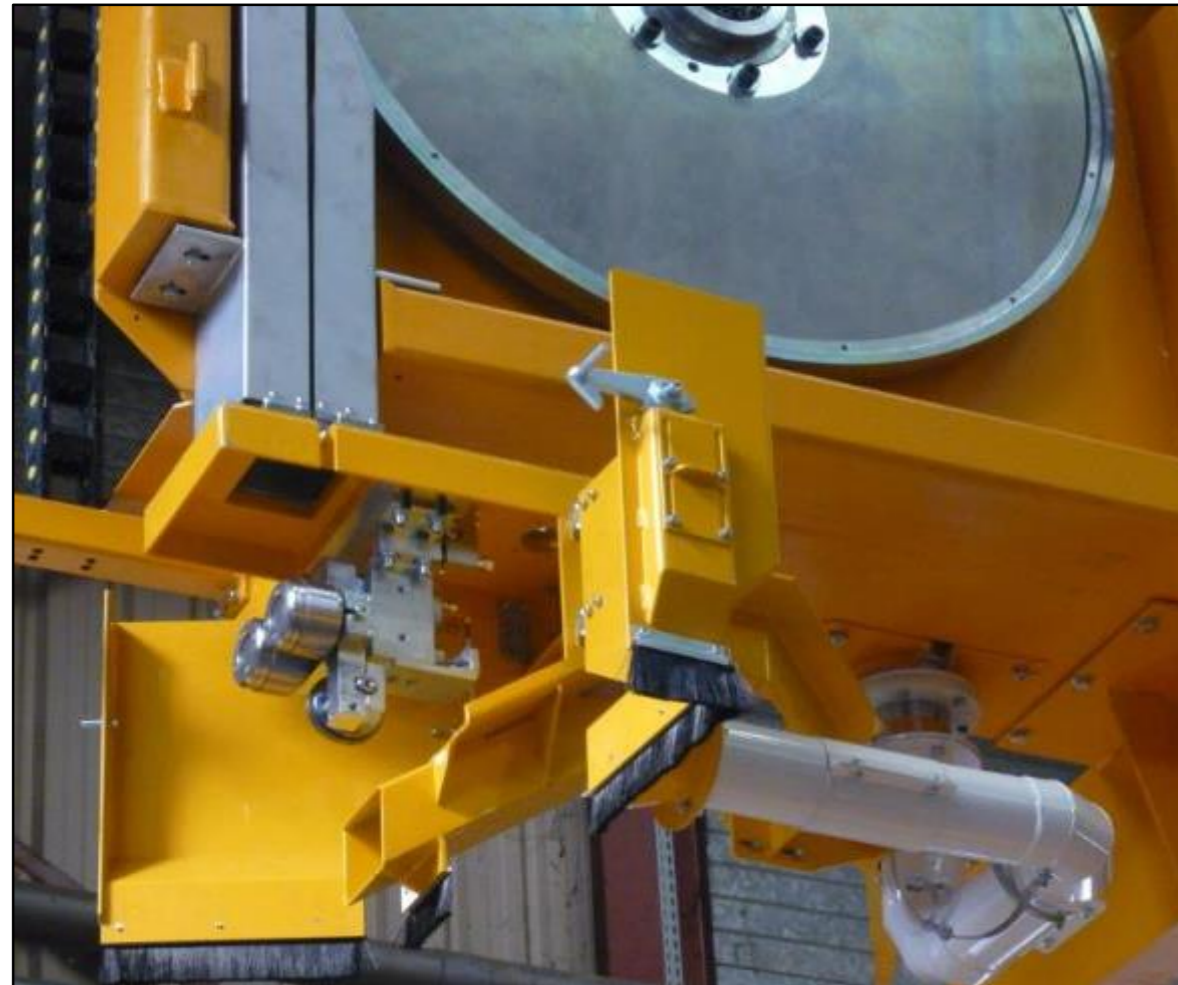

Chip upper suction (above the cut)



Steel wheel ring offering



Our Standard improvements offers

- Far higher longevity,
- Less production shutdown,
- Durable cut reliability.

IMPROVEMENTS TO REDUCE MAINTENANCE COSTS

sermaLUBE[®]

High-efficiency MQL-system* designed by SERMAS

- Suitable for heavy-duty industry and any machine
- Increased productivity
- Optimized maintenance
- Minimum & fully-adjustable lubricant consumption
- Extended cutting tool lifetime

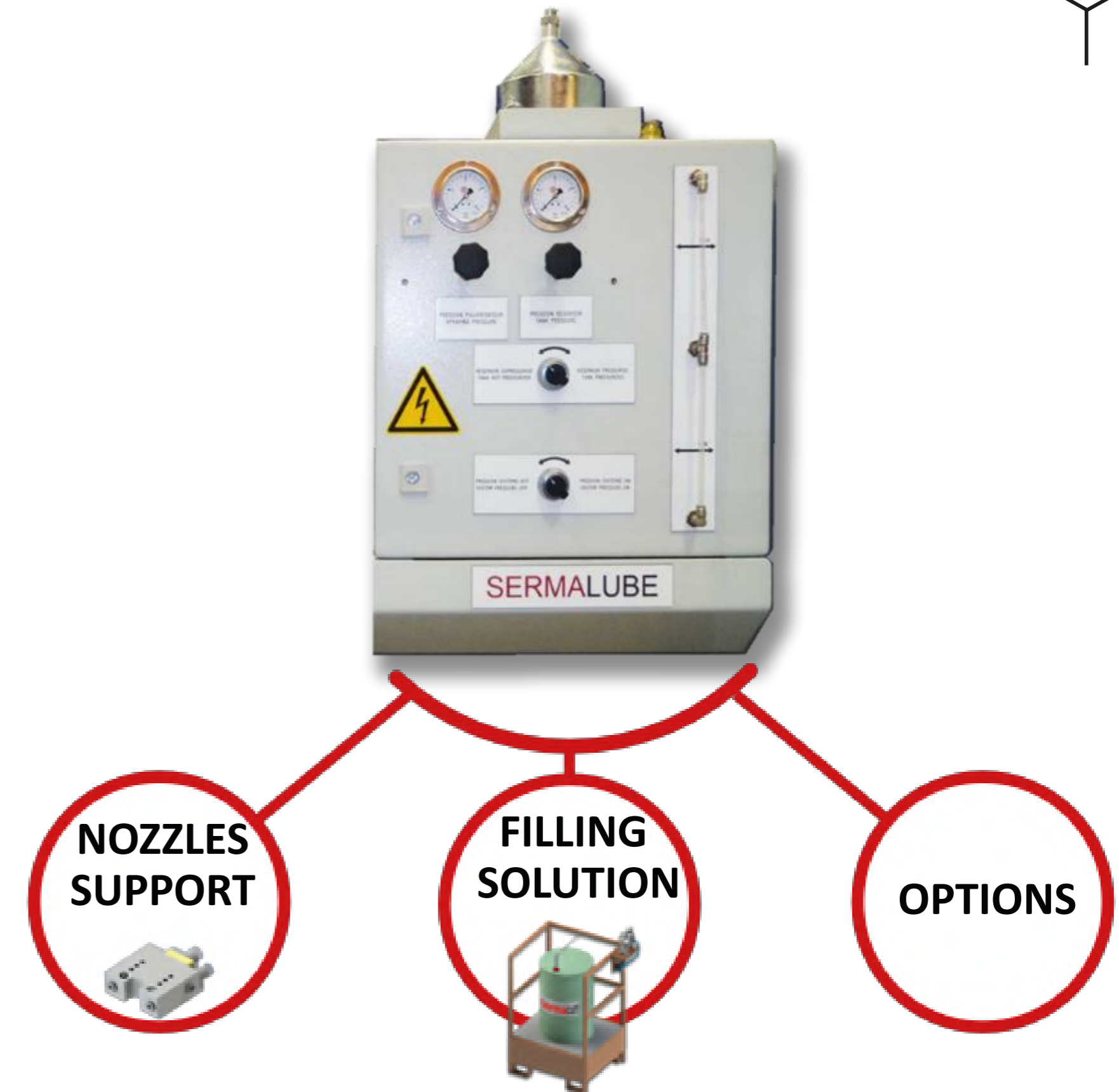

()Minimum Quantity Lubrication*

IMPROVEMENTS TO REDUCE MAINTENANCE COSTS

sermaLUBE[®]

100% customized project adapted to your specific requirements

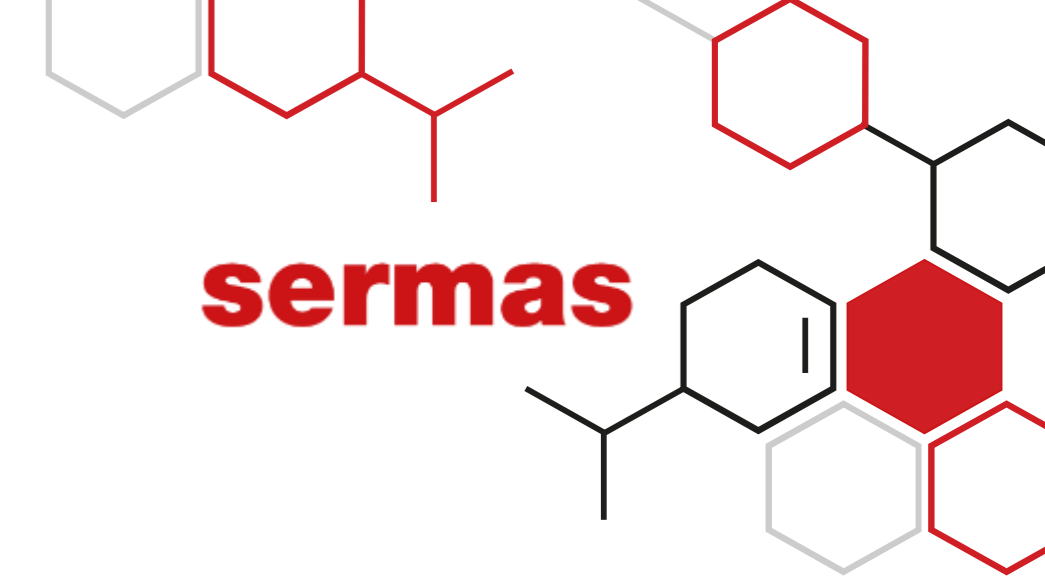

Pre-Study & Engineering

Design & 3-D layout

Manufacture & Delivery

On-site installation & commissioning by Sermas expert to guarantee optimized performance

IMPROVEMENTS TO REDUCE MAINTENANCE COSTS

sermaLUBE[®]

Examples of previous realizations from design to on-site installation

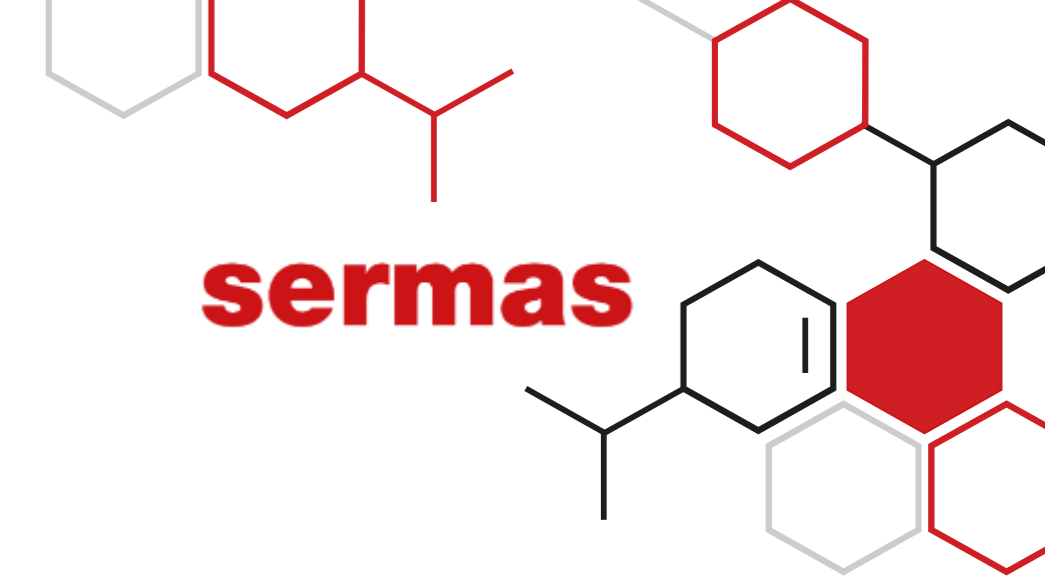

Support for band saw with short nozzle head

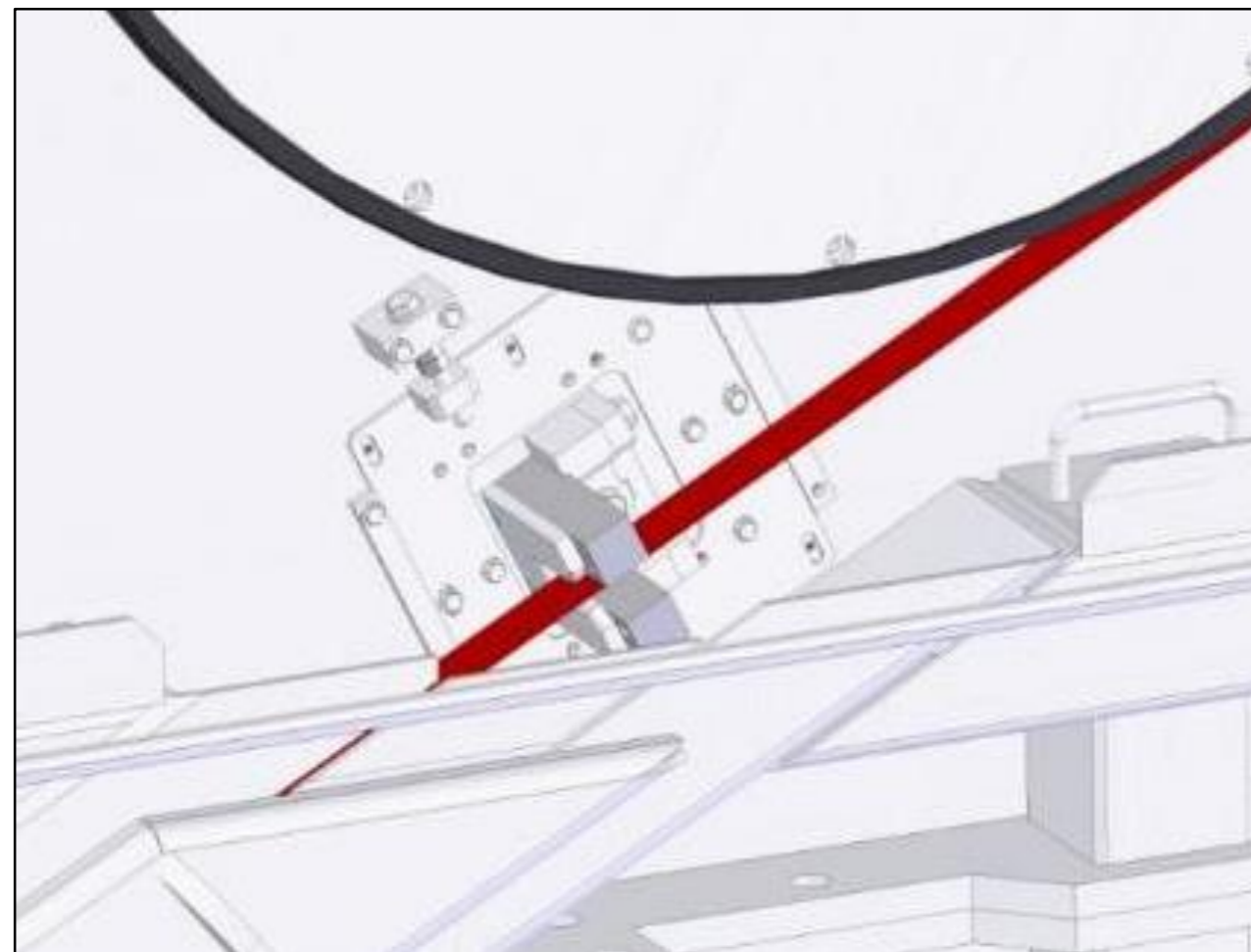

Short nozzle head (22)

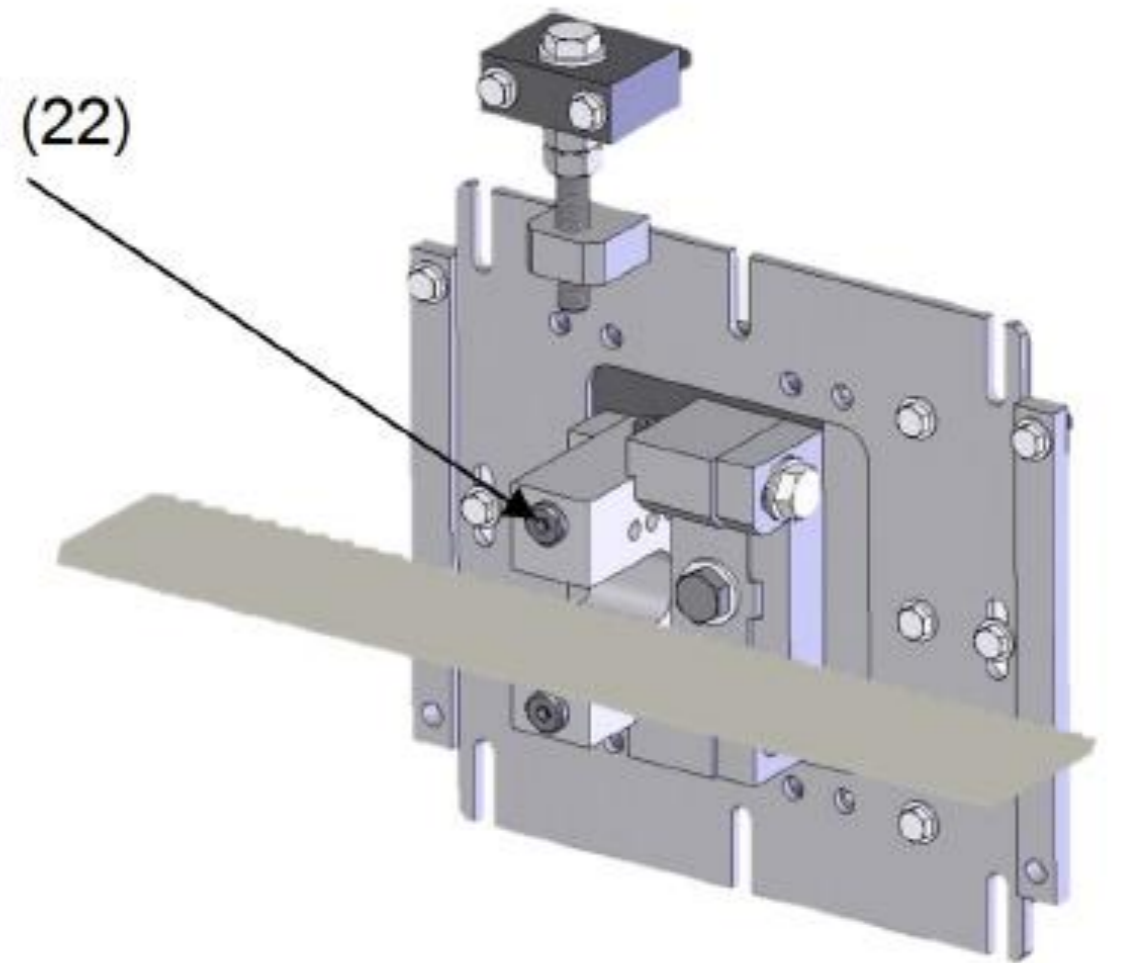

IMPROVEMENTS TO REDUCE MAINTENANCE COSTS

sermaLUBE[®]

Examples of previous realizations from design to on-site installation

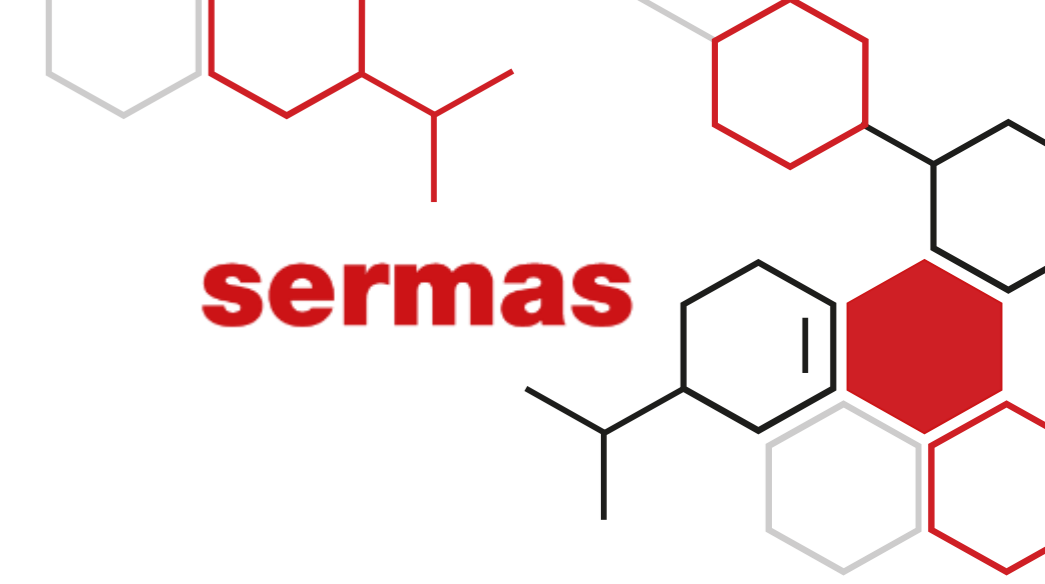

□ *Centralized fill-in system*

GET YOUR MACHINE IMPROVED TO INCREASE ITS PROFITABILITY WITH UP-TO-DATE MATERIALS

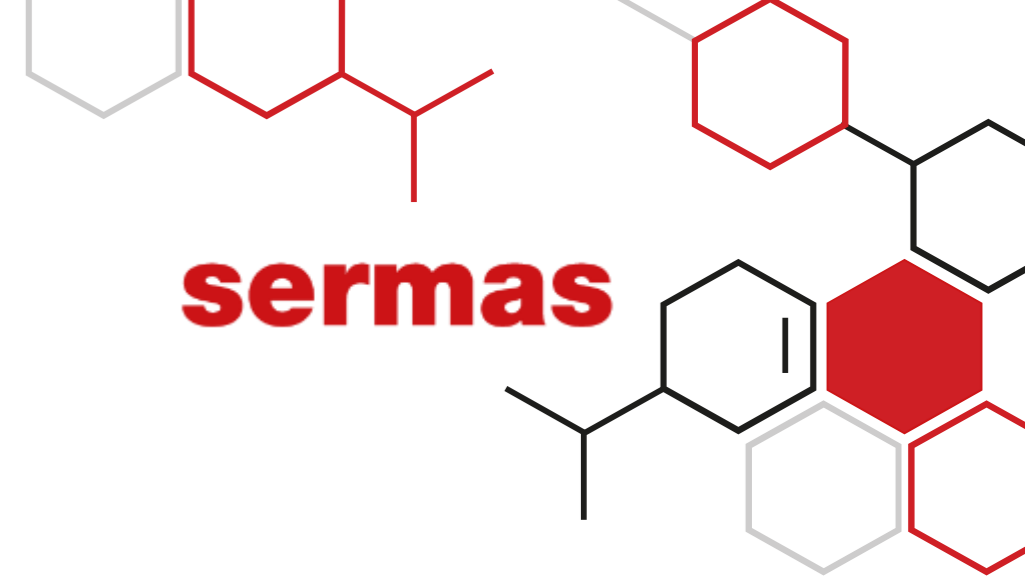

BEFORE



SOLUTION

- > Product quality improvement
- > Higher performance of your process

- > Easier maintenance, operations and use
- > Retrofit of electrical material & new-generation drives / PLC

AFTER



SERMAS-DESIGNED SOLUTIONS TO UPGRADE EQUIPMENT

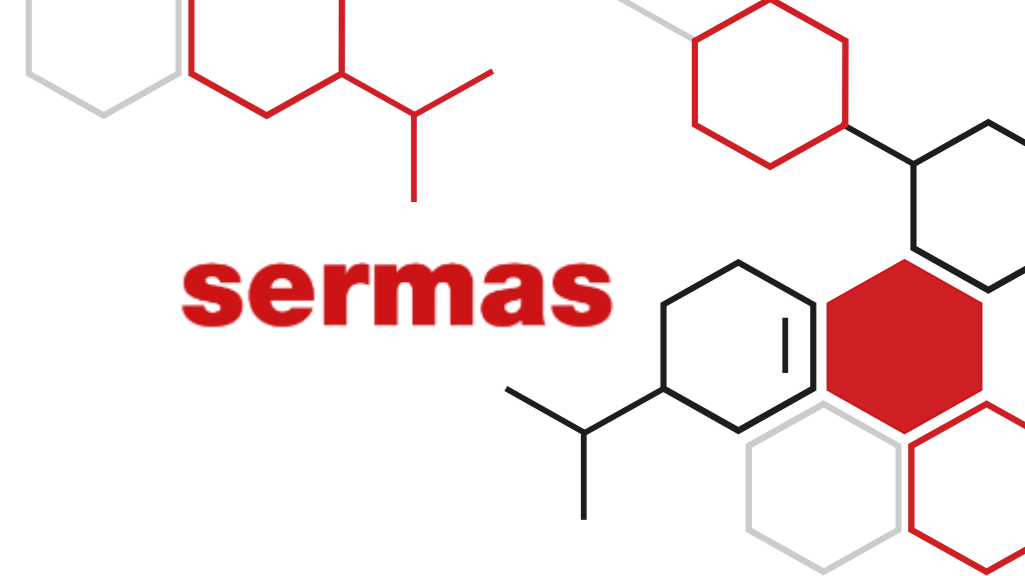

Full-automated material compatible with your existing process

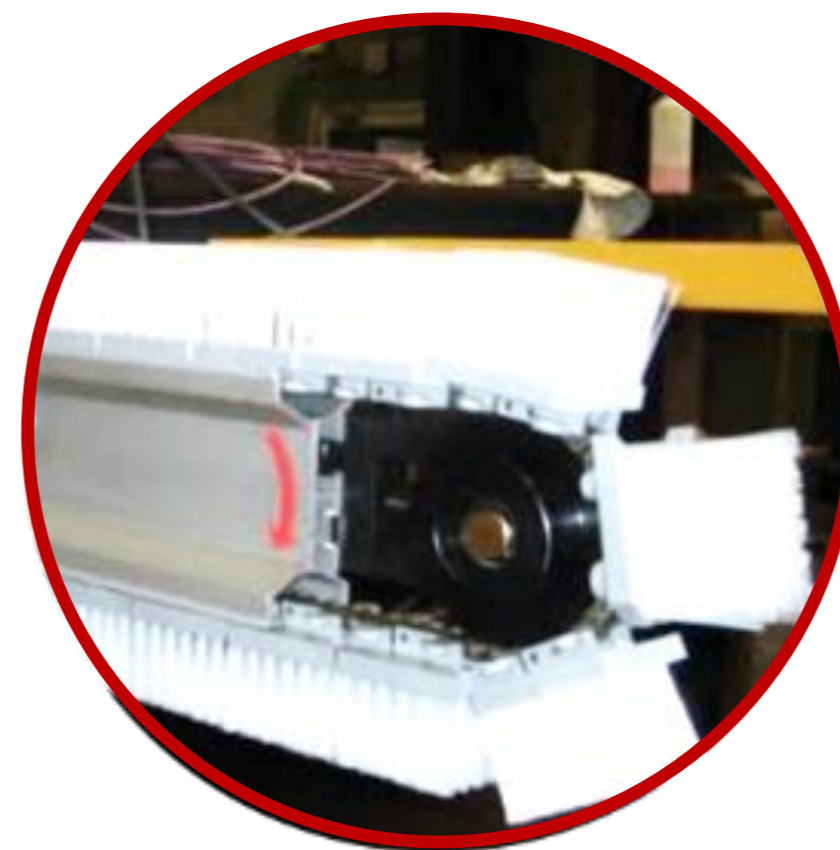
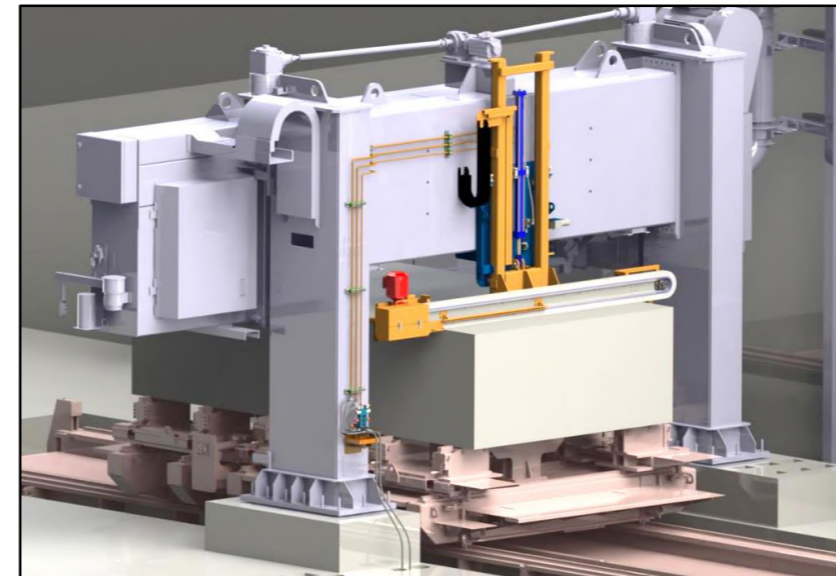
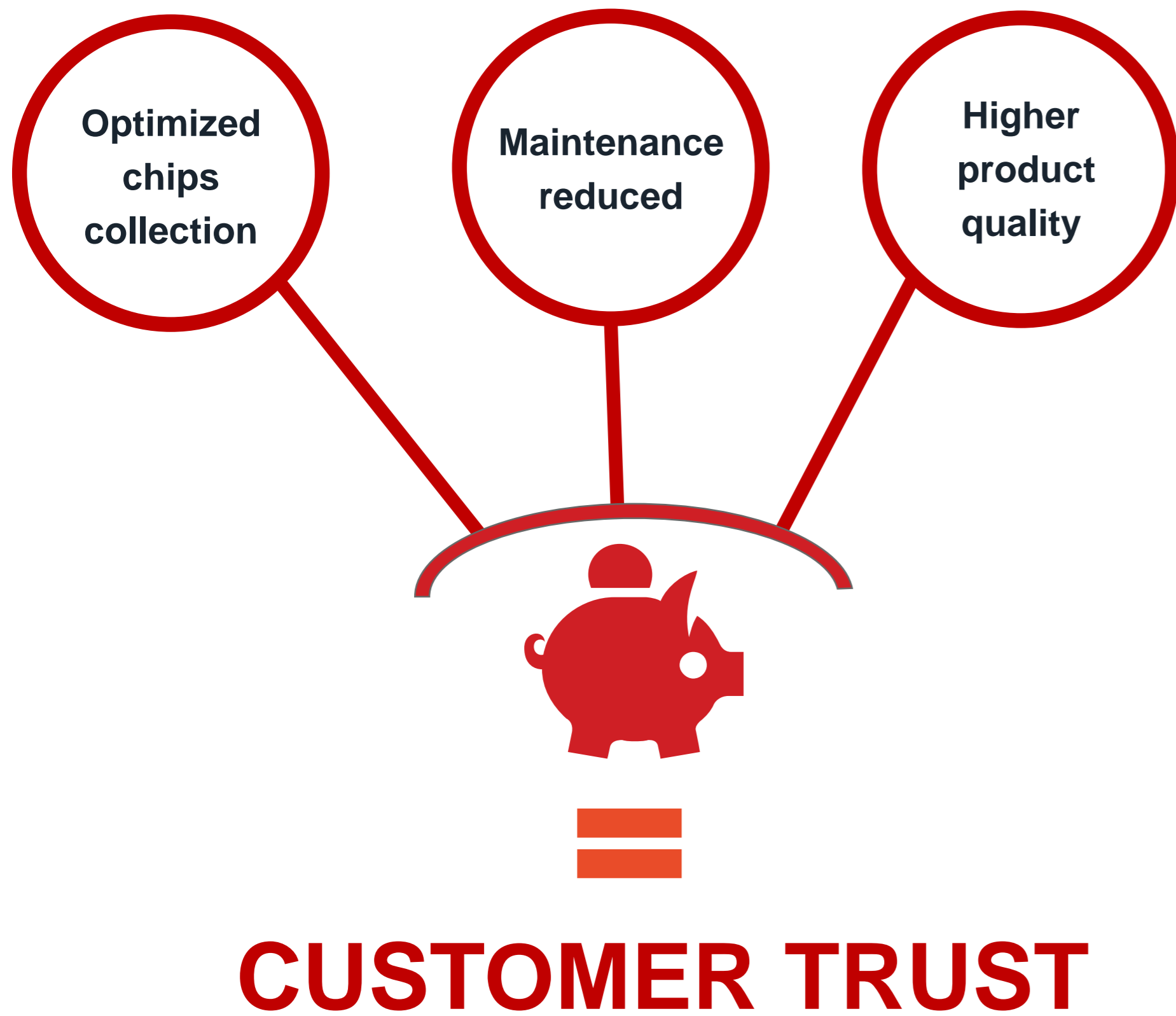

Chip brushing system



HIGH-PERFORMANCE CONSUMABLES: SAW-BLADES & LUBRICANTS

sermas

Full-automated material compatible with your existing process



RETROFIT

Replacement of existing Milling Head



SERVICE CENTERS IN THE WORLD

sermas



OUR MISSION

To be the ideal partner for Aluminum producers for the supply and service delivery of equipment goods



sermas
INDUSTRIE

Complete sawing solutions

44 EMPLOYEES + 500 EQUIPEMENT UNITS SOLD 14 M Euro GLOBAL REVENUES 2018 47 years EXPERTISE

Our Business Sectors

SAWING EQUIPMENT	ALUMINIUM CAST PLATE EQUIPMENT	EQUIPMENT FOR ANODES & CATHODES SEALING
CASTING		PRIMARY

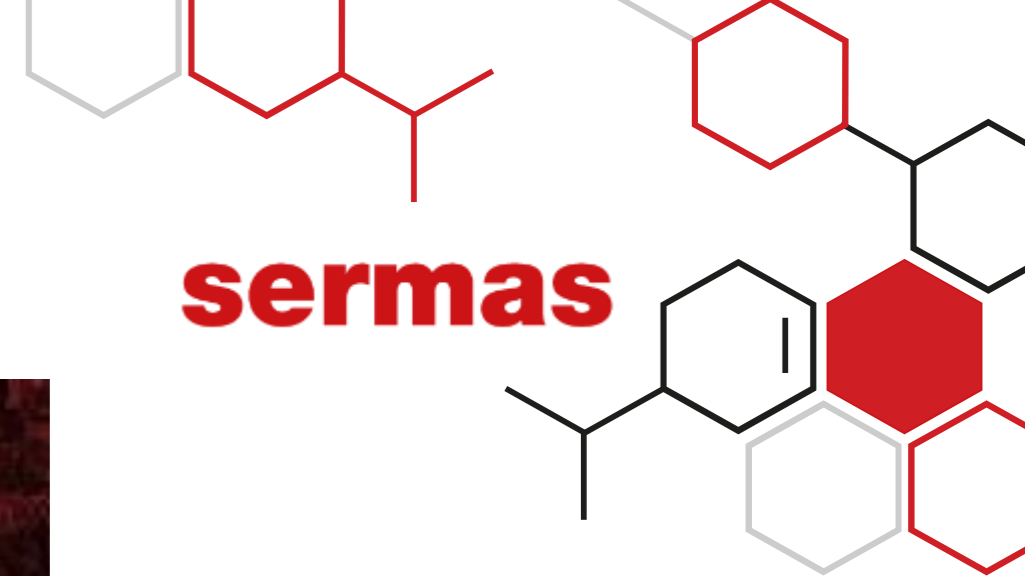

The logo for sermas, featuring the word "sermas" in a bold, lowercase, sans-serif font. To the right of the text is a stylized molecular structure composed of interconnected hexagons and lines, with one hexagon highlighted in red.

Advantages to work with us



APPROACH

Customers' based approach – adapted to your needs



EXPERTISE

Expertise recognized **internationally**



DEDICATION

47 years of dedication to the **aluminium industry**



IMPROVEMENT

We continuously strive to improve ourselves



ROI

Focused on Return On Investment

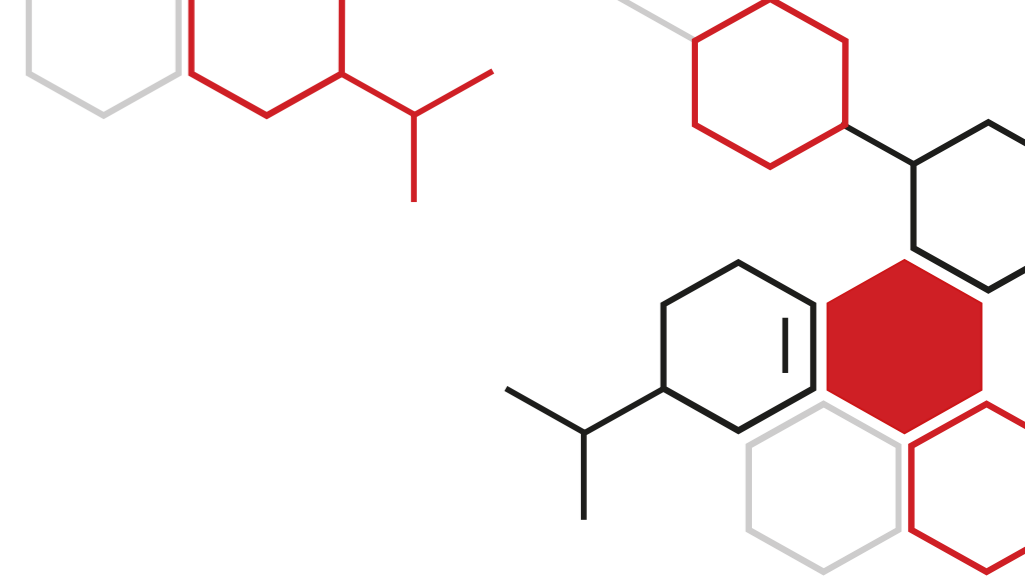

sermas

www.sermas.com
services@sermas.com

